

I

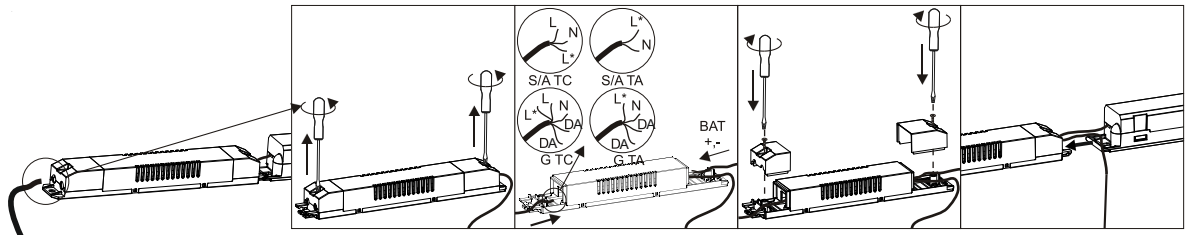

II

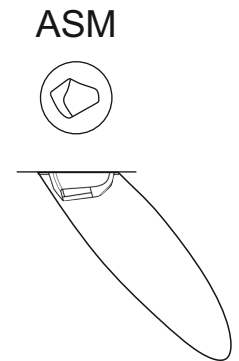
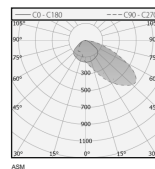
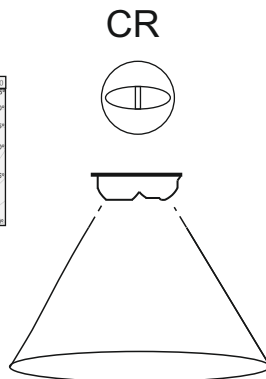
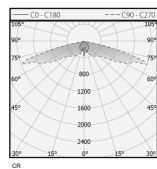
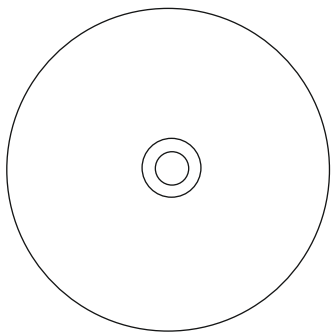
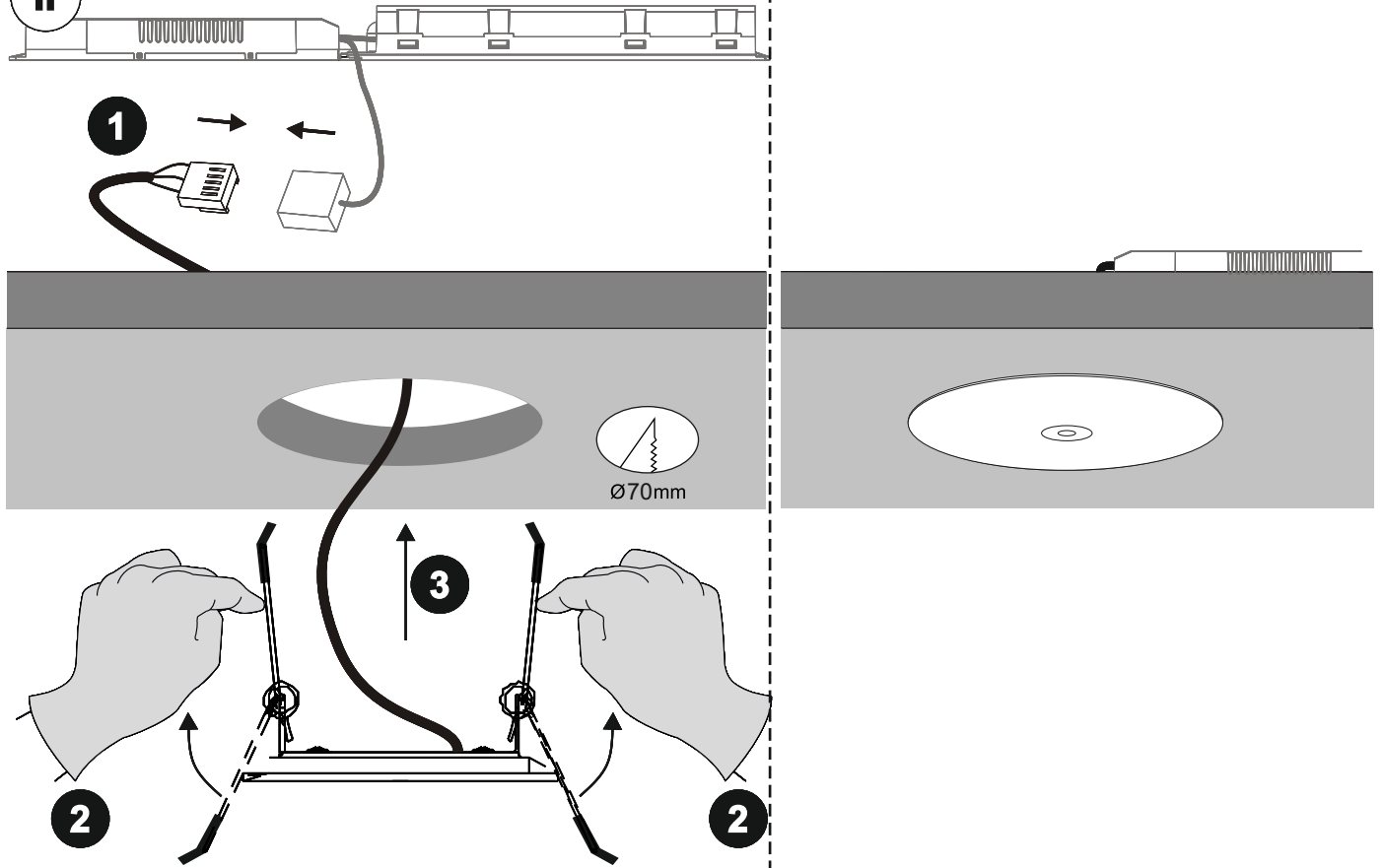

Źródło światła zastosowane w tej oprawie oświetleniowej powinno być wymieniane wyłącznie przez producenta lub jego przedstawiciela serwisowego lub podobnie wykwalifikowaną osobę.
The light source contained in this luminaire shall only be replaced by manufacturer or his service agent or a similar qualified person.

Akumulatory umieszczone w oprawie oświetleniowej są wymiennalne.
The batteries contained in this luminaire are replaceable.

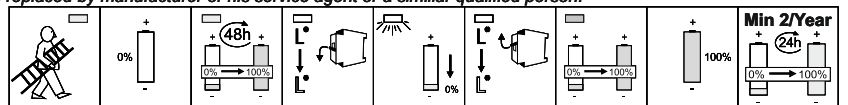

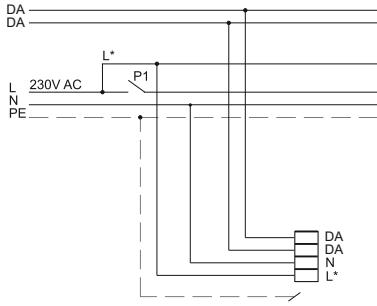

| SYSTEM | MODE |
|-----------|---------|
| CTI2 DALI | TA (NM) |

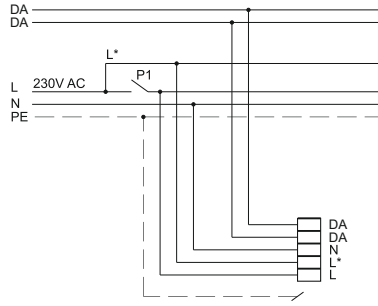

| SYSTEM | MODE |
|-----------|----------------------|
| CTI2 DALI | TC on/off (switch M) |

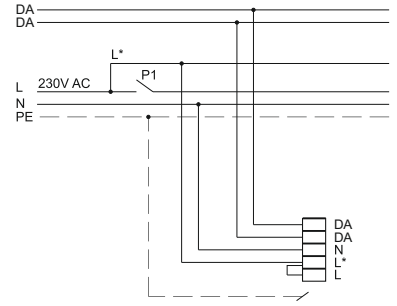

| SYSTEM | MODE |
|-----------|--------|
| CTI2 DALI | TC (M) |

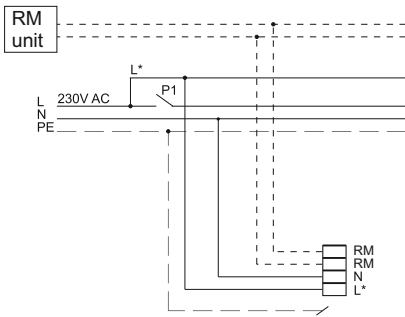

| SYSTEM | MODE |
|--------|---------|
| ATI | TA (NM) |

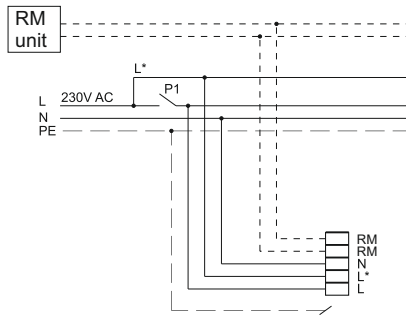

| SYSTEM | MODE |
|--------|----------------------|
| ATI | TC on/off (switch M) |

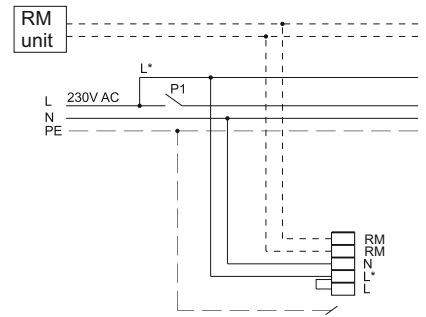

| SYSTEM | MODE |
|--------|--------|
| ATI | TC (M) |

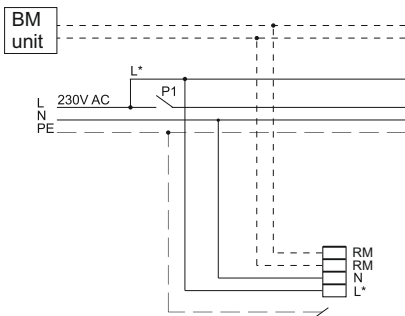

| SYSTEM | MODE |
|--------|---------|
| STI | TA (NM) |

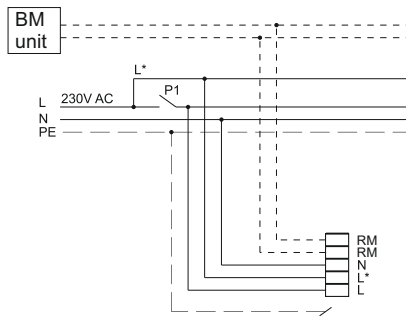

| SYSTEM | MODE |
|--------|----------------------|
| STI | TC on/off (switch M) |

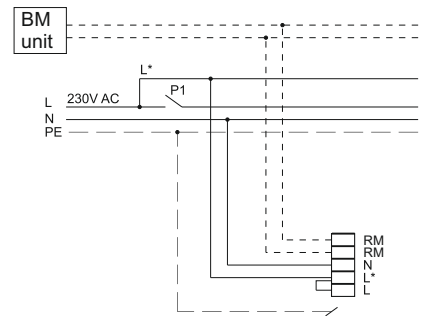

| SYSTEM | MODE |
|--------|--------|
| STI | TC (M) |

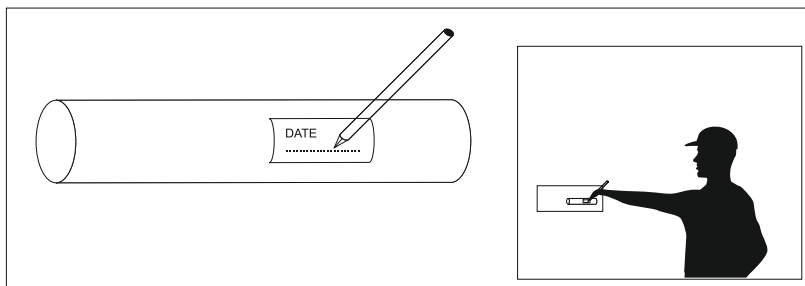

P1 - wyłącznik oświetlenia podstawowego
General lighting switch

- — — — dla opraw w I klasie (for Luminaires in Safety Class I)
- - - - - opcjonalnie (optional)